



INDUSTRIAL 6.0

Advantages

- High luminous efficacy up to 180 lm / W
- Diffuser made out of PC or PMMA
- IP66 luminaire
- IK08 or IK03 resistance class
- Operation in temperatures from -30°C to + 50°C for version I-III, version IV from 0°C to + 40°C



Industrial:LED 6.0 I

IND6-I-WW	32	5450	3000K	>80	IP 66	110°	2,0kg
IND6-I-NW	32	5650	4000K	>80	IP 66	110°	2,0kg
IND6-I-DW	32	5700	5000K	>80	IP 66	110°	2,0kg

Industrial:LED 6.0 II

IND6-II-WW	42	7200	3000K	>80	IP 66	110°	2,0kg
IND6-II-NW	42	7450	4000K	>80	IP 66	110°	2,0kg
IND6-II-DW	42	7500	5000K	>80	IP 66	110°	2,0kg

Industrial:LED 6.0 III





IND6-III-WW	66	11500	3000K	>80	IP 66	110°	2,4kg
IND6-III-NW	66	11850	4000K	>80	IP 66	110°	2,4kg
IND6-III-DW	66	11900	5000K	>80	IP 66	110°	2,4kg

Industrial:LED 6.0 IV

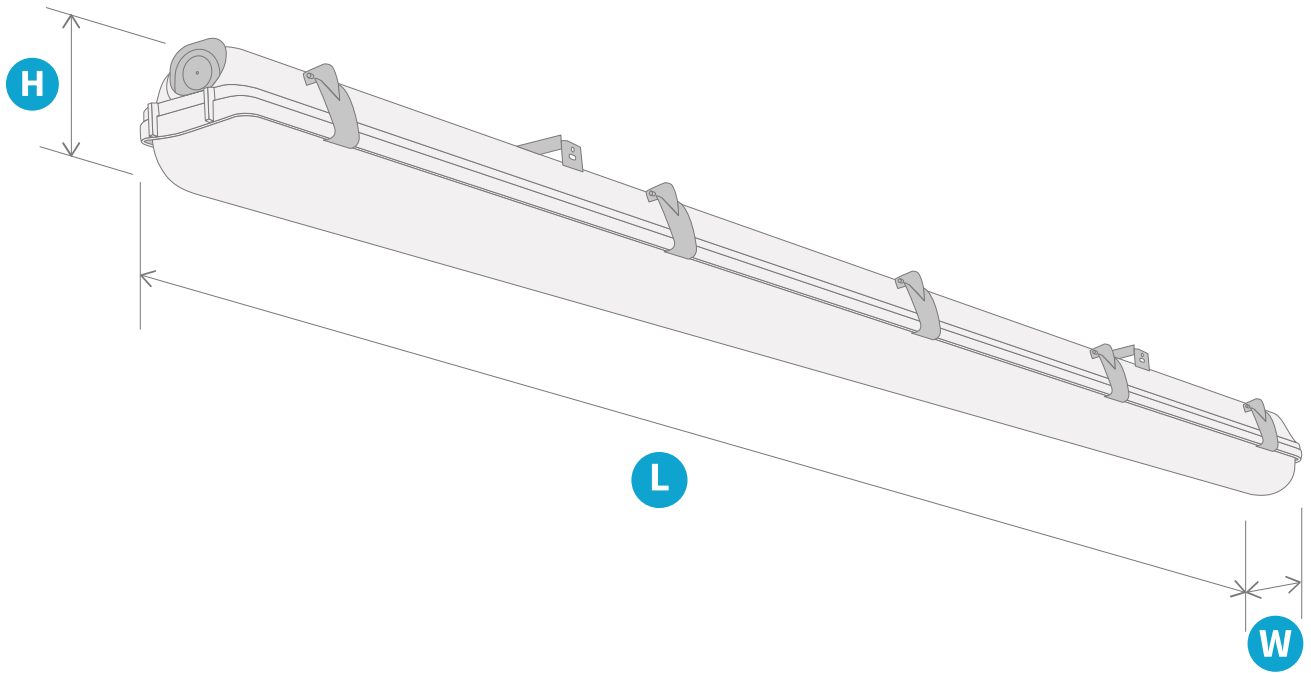
IND6-IV-WW	97	16000	3000K	>80	IP 66	110°	2,4kg
IND6-IV-NW	97	16500	4000K	>80	IP 66	110°	2,4kg
IND6-IV-DW	97	16550	5000K	>80	IP 66	110°	2,4kg

Dimensions and Logistics



	H	L	W				
IND6-I	80	1277	97	IND6-I	10	100	160x80
IND6-II	80	1277	97	IND6-II	10	100	160x80
IND6-III	80	1573	87	IND6-III	10	100	160x80
IND6-IV	80	1573	87	IND6-IV	10	100	160x80

Montage



Surface mounting



Suspended



Luminous Intensity Distribution

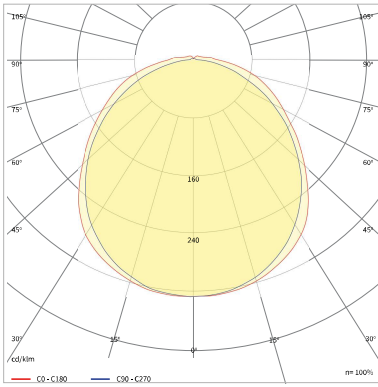

Available Configurations



Size	III	IV	
1 Color temperature	WW 3000K	NW 4000K	DW 5000K
2 Optyka	110° Beam angle		
3 Material D- Diffuser/ H-Housing	D1 PC (IK08) H1 PC	D2 PMMA (IK03) H3 GRP	
4 Control	DALI DALI		
5 Extras (I,II,III)	PRO -30°C to +50°C	96M 8 years warranty	120M 10 years warranty

*In the IV version only ON/OFF and DALI models are available